

chipboard layer 1 (bottom)

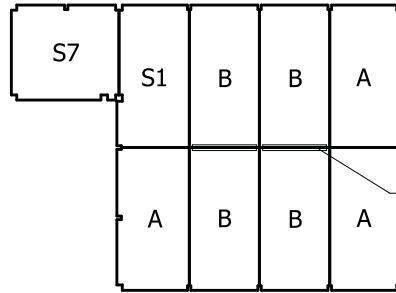

parts list		DFL 444 PL
quantity	description	
3	A	
4	B	
1	S1	
1	S7	
2	Z	

chipboard layer 2 (top)

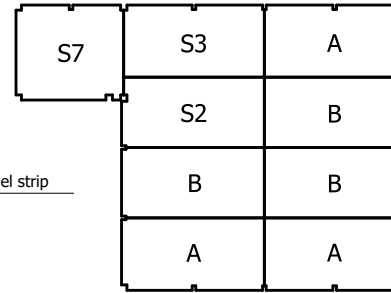

parts list		DFL 444 PL
quantity	description	
3	A	
3	B	
1	S2	
1	S3	
1	S7	

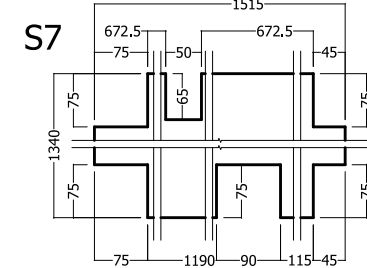
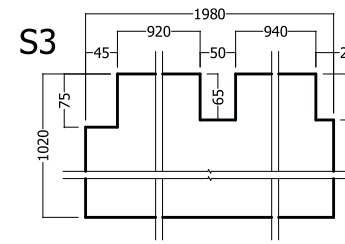
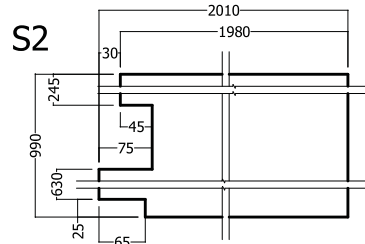
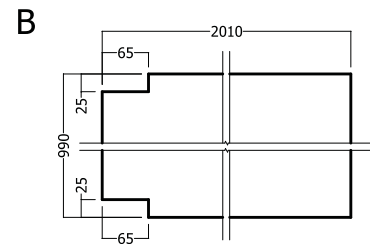
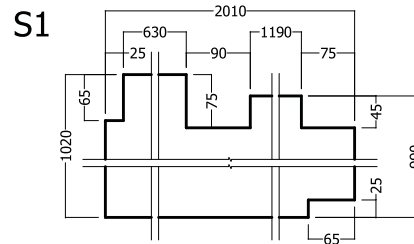
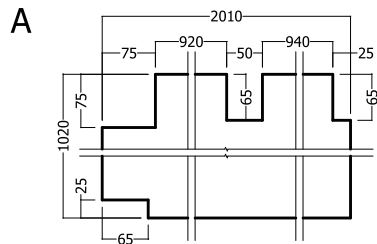
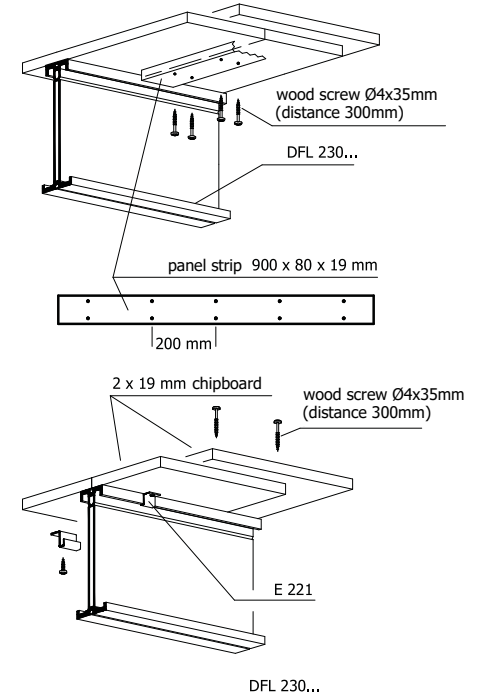

**Important:**

The base plates (in two layers) assume the function of a rigid ceiling plate. Mounting is done with floor hooks E221 that establish the connection between plate and beam! These are fastened with wood screws. This is the only way to transfer the horizontal forces via the E221 floor hooks on the beams.

Note: a distance of approx. 200 mm between the floor hooks E221 in the edge area must be observed!