

* = Cutting length of the extrusion

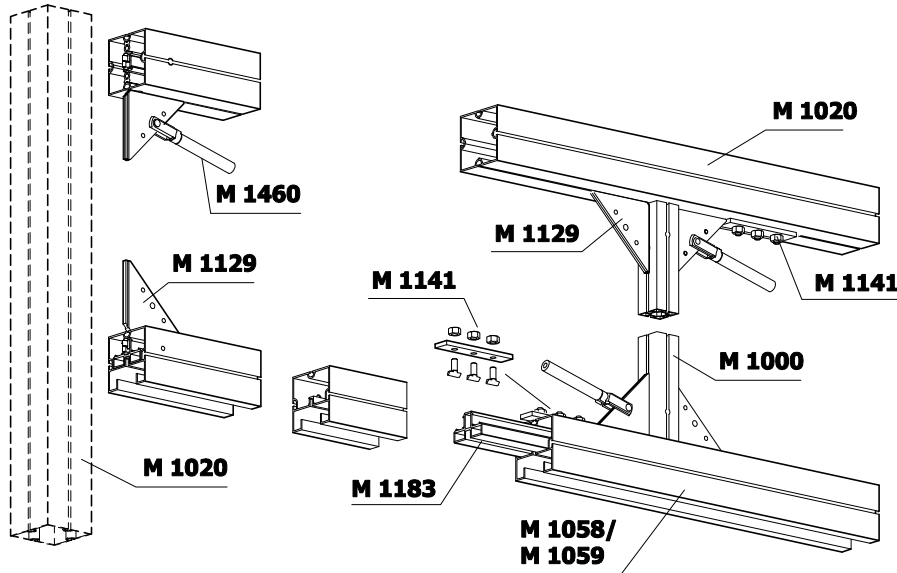

Parts list for Truss girder M 777

Quantity	Art.-No:	Length:	Description:
2	M 1020	3425	Square extrusion with each 4 drillings for M 1123 and drillings (with 90° turn) for adaptor M 1101 on one side
1	M 1058	3700	Square extrusion with 4 drillings for M 1183 on both sides
2	M 1058	1575	Square extrusion with each 4 drillings for M 1151 and M 1183
3	M 1000	270	Square extrusion punched for Z 961/8 on both sides
2	M 1101		Tension lock adaptor mounted
2	M 1151		Tension lock adaptor mounted
6	Z961/8		Tension lock mounted
4	M 1460	1501	Round tube with M 1137 mounted on both sides
1	M 1123	480	Extension adaptor
2	M 1183	480	Extension adaptor
16	M 1129		Angle reinforcement
4	M 1141		Anti-slipping device

Attention : Truss systems differing from the standard ones must be recalculated by a structural engineer